

Othman O. Khalifa · Amirasyid Densibali ·
Waleed Faris

Image processing for chatter identification in machining processes

Received: 29 April 2005 / Accepted: 1 August 2005 / Published online: 15 February 2006
© Springer-Verlag London Limited 2006

Abstract Identifying chatter or intensive self-excited relative tool–workpiece vibration is one of the main challenges in the realization of automatic machining processes. Chatter is undesirable because it causes poor surface finish and machining accuracy, as well as reducing tool life. The identification of chatter is performed by evaluating the surface roughness of a turned workpiece undergoing chatter and chatter-free processes. In this paper, an image-processing approach for the identification of chatter vibration in a turning process was investigated. Chatter is identified by first establishing the correlation between the surface roughness and the level of vibration or chatter in the turning process. Images from chatter-free and chatter-rich turning processes are analyzed. Several quantification parameters are utilized to differentiate between chatter and chatter-free processes. The arithmetic average of gray level G_a is computed. Intensity histograms are constructed and then the variance, mean, and optical roughness parameter of the intensity distributions are calculated. The surface texture analysis is carried out on the images using a second-order histogram or co-occurrence matrix of the images. Analysis is performed to investigate the ability of each technique to differentiate between a chatter-rich and a chatter-free process. Finally, a machine vision system is proposed to identify the presence of chatter vibration in a turning process.

Keywords Chatter vibration · Intensity histogram · Co-occurrence matrix · Image processing

1 Introduction

In manufacturing industries, an automatic machining process is regarded as one of the most effective methods to meet the growing demands of increased product quality, greater product variability, shorter product lifecycles, and reduced cost and global competitions. The recent review on machining process monitoring and control—the state-of-the-art by Liang et al. [1]—outlined four main motives towards automatic machining processes, which are: increased productivity, improved part quality, reduced costs, and relaxed machine design constraints. One of the obstacles in realizing an automatic machining process is the presence of unwanted vibration. This unwanted vibration, known as chatter in machining processes, has been found to be the main cause of poor quality surface finish and reduced tool life, as well as poor machining accuracy. Chatter is sometimes unavoidable phenomenon in machining. It is defined as the self-excited violent relative dynamic motion between the cutting tool and the workpiece. Chatter is undesirable due to its adverse effects on the product surface quality, operation cost, machining accuracy, tool life, machine-tool bearings, and machine-tool life [2]. The conversion of raw material into manufactured products usually requires some sort of material removal process to be performed. By far the most common material removal processes are the so-called chip-forming types. Chip-forming, or the act of shaving metal from a workpiece to produce a desired geometric shape, is carried out using a machine tool. Milling machines, engine lathes, twist drills, and shaping machines are but a few examples of the diverse types of machine tools that exist. A close up view of the turning process is shown in Fig. 1.

Several methods were proposed by some researchers for automatic chatter detection [3–7]. These methods mainly include the following approaches. The first method is combining AE signals as a source of information and neural networks as pattern recognition. The second is using the nonlinear vibration characteristics of the electro-rheological (ER) fluid. The third is using scalar indicators that might be entropy, calculated from a power spectrum, and calculated

O. O. Khalifa (✉) · A. Densibali · W. Faris
Electrical and Computer Engineering Department,
Kulliyyah of Engineering,
International Islamic University of Malaysia,
Jalan Gombak,
53100 Kuala Lumpur, Malaysia
e-mail: khalifa@iiu.edu.my

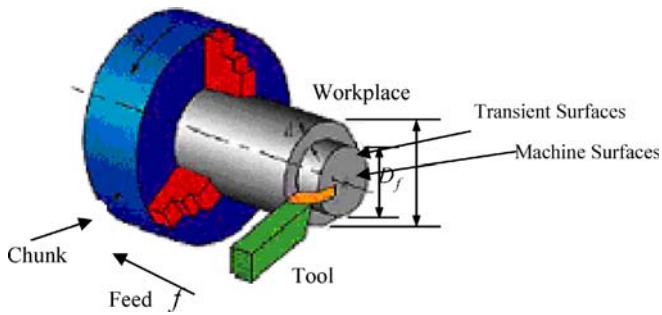

Fig. 1 Turning process

from fluctuations of a record signal. All of the previous approaches have their own limitations and require post-processing most of the time. The skilled operator can identify the chatter in a workpiece visually easily and quickly.

Therefore, it is more efficient to use an automated visual approach as a chatter-detection tool.

This paper proposes the utilization of an image processing system to correlate the surface roughness of a machined part to the level of machining chatter in the turning process by analyzing images of the machined workpiece surface. Some image-processing techniques are utilized on the images to find the correlation. The final aim is to identify the presence of chatter in machining by using an online machine vision system. To the best of the authors' knowledge, this technique has never been used before in chatter detection. Advantages of this technique include the ease of setting up the required level of chatter vibration which can be tolerated. This can be easily done using an index of product surface quality required by the customer or a technical requirement for a mechanical product. The existing available methods of identifying chatter are lacking in this aspect.

2 Surface roughness evaluation

Surface roughness evaluation finds its main application in the quality inspection of machining processes. In industry, the inspection and assessment of surface finish is either performed offline using a stylus-type measurement instrument by an operator or online (machine and computer vision). Offline measurement usually requires the removal of the part from the machine, cleaning and testing on an offline surface finish measuring instrument, and, subsequently, making the necessary adjustments to the machine [8]. Inspection requires interruption of the processing and, if necessary, cleaning of the part prior to inspection. If the part meets the required specifications, it is accepted; if not, the part or the entire batch may be scrapped or reworked. Such methods are slow and obviously not adaptable for real-time process control. Current trend shows an increased interest in online inspection using non-contact measurement systems. Non-contact measurement is performed using optical sensors. This technique is preferred for surface roughness measurement, primarily because of the potential for integration into automatic manufacturing systems. These methods have the advantage of being non-contact, therefore, non-

damaging, and can be used at some distance from the surface being measured. They are faster than contact methods, and have the capability of measuring surface roughness over an area and not just a line [9]. Non-contact measurement can also be applied during the machining process so that the defect on the surface finish can be identified early. Many research efforts have concentrated on utilizing the machine vision system equipped with optical sensors in the surface roughness evaluation. One of the recent published papers by Kumar et al. [10], the machine vision system is utilized to find the correlation between the arithmetic average of gray level (G_a) and the surface roughness for machined surfaces (ground, milled, and shaped). The original image of the machined surfaces are digitally magnified using cubic convolution interpolation, and then the edge of the images are enhanced using a linear edge crispensing algorithm. Regression analysis of the results indicated a good linear relationship between R_a and G_a indices, along with a high level of accuracy. It is finally established that digital magnification followed by qualitative evaluation of surface images could very well be used for engineering surfaces quantification. Sodhit et al. [11] introduced a parameter called the optical roughness indicator (ORI) to determine the surface roughness of grinded materials. This parameter indicates the change in size of the illuminated area. The roughness measurement is based on the speckle pattern caused by a laser beam. A comparative study was done by Hoy et al. [9]. Two techniques for quantifying surface roughness were examined and compared. The techniques are histogram intensity and two-dimensional fast Fourier transform. This comparative study was carried out on milling and turning processes.

The other approach to measure the surface roughness is through texture analysis. Texture is defined by an attribute representing the spatial arrangement of the grey levels of the pixels in a region of a digital image [12]. It has played an important role in many areas, including medical imaging, remote sensing, and industrial inspection. The approaches for analyzing texture are very diverse and differ from each other mainly by the method used for extracting textural features. There are four widely used approaches to describe the texture of a region, as reviewed in [13]. These are: structural, model-based, statistical, and transform methods. The statistical approach represents texture by the use of well-defined primitives. In other words, a square object is represented in terms of the straight lines or primitives that form its border. In a model-based approach, an attempt is made to represent texture in an image using sophisticated mathematical models (such as fractal or stochastic), whereas in the statistical approach, representations of texture are based on properties governing the distribution and relationships of gray-level values in the image. In the transform approach, the texture

Fig. 2 Laplacian mask 3×3

-1	-1	-1
-1	8	-1
-1	-1	-1

Fig. 3 a, b Cutting parameters: spindle speed=460 rpm; cutting speed= 58 m/min; depth of cut=0.05 mm; feed rate=0.051 mm/rev; rake angle=9°, clearance angle=1°. **a** Chatter-free sample. **b** Displacement in *Y* direction

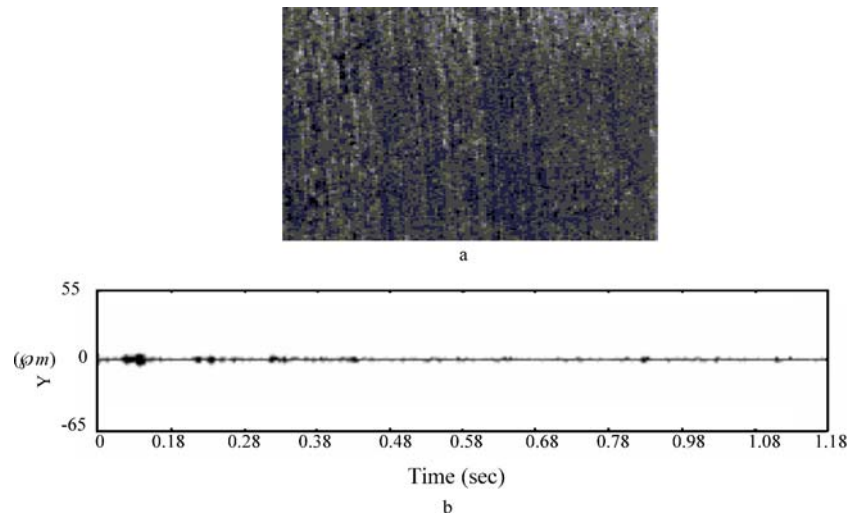

properties of the image may be analyzed in a different space, such as the frequency or the scale space. These methods are based on the Fourier, Gabor, or wavelet transform. Another aspect to consider is the parameters used in evaluating the machined surfaces. There are many parameters currently being used. The choice of parameters are dependent upon the application in which the arithmetic average height being is the most universally used. A good review of roughness parameters was written by Gadelmawla et al. [15]. In their paper, the authors developed software called SurfVison that computed 59 roughness parameters.

The underlying theory of chatter in turning processes is complex and highly non-linear. There are two main theories currently available in the literature. The most dominant theory was proposed by Tobias [16], which is known as regenerative chatter theory. The other theory,

called the resonant theory of chatter, was proposed by Amin [17]. It is not the intention of this paper to elaborate on the chatter theory and the readers are advised to refer to [2,16,17] for the complete details. The theoretical background will focus on several parameters and image enhancement techniques used in this paper to evaluate the surface roughness of the images. Brief descriptions are given in the following sections.

2.1 G_a index

The G_a index introduced in [10] is the arithmetic average of the gray level. It is used to predict the actual surface roughness of the workpiece. The arithmetic average of the gray level can be expressed as:

$$G_a = \left(\sum (|g_1 - g_m| + |g_2 - g_m| + |g_3 - g_m| \dots + |g_n - g_m|) \right) / n \quad (1)$$

Fig. 4 a, b Cutting parameters same as Fig. 3, but rake angle=0° and clearance angle=10°. **a** Chatter turning sample. **b** Displacement in *Y* direction

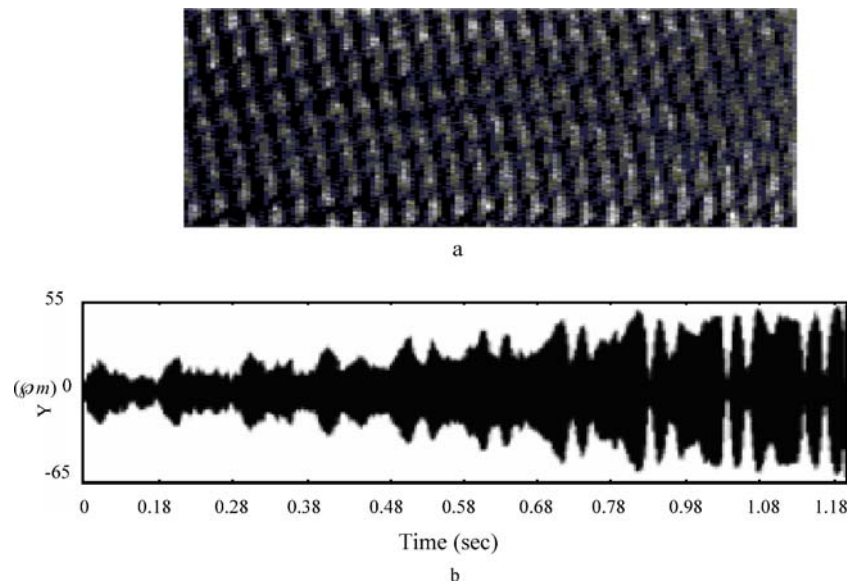

where n is the number of sampling data, g_1, g_2, \dots, g_n are the gray level values of a surface image along one line and g_m is the mean of the grey values and can be determined using the following:

$$g_m = \left(\sum (g_1 + g_2 + \dots + g_n) \right) / n \quad (2)$$

2.2 Sharpening spatial filter

The principal objective of sharpening is to highlight the fine detail in an image or to enhance detail that has been blurred. There are many techniques under spatial sharpening, such as gradient (first-order derivative), Laplacian (second-order derivative), etc. In this paper, the Laplacian filter is utilized to enhance the details of the image. In order to simplify the operation, composite Laplacian 3×3 filters or masks are used, as shown in Fig. 2. The composite Laplacian combines two operations. The first operation is to filter the image by using the Laplacian filter and the second operation is to subtract the filtered image with the original image. The composite Laplacian filter used in this paper is the following filter: the total summation of each element gives the value of unity, which will avoid amplitude bias in the processed images.

3 Gray-level co-occurrence matrix (GLCM)

Gray-level co-occurrence matrix (GLCM) is a technique that allows for the extraction of statistical information from the image regarding the distribution of pairs of pixels. The GLCM of an image is an estimate of the second-order joint probability, P_{δ}^{ij} of the intensity values of two pixels (i and j), a distance δ apart along a given direction θ , i.e., the probability that i and j have the same intensity. It is computed by defining a direction and a distance, and pairs of pixels separated by this distance, computed across the defined direction, are analyzed. A count is then made of the number of pairs of pixels that possess a given distribution of gray-level values. Each entry of the matrix thus corresponds to one such gray-level distribution.

Examples of parameters computed from the co-occurrence matrix are the inertia (moment of order 2), uniformity, contrast, and the entropy. The contrast of an image refers to how much difference, or definition, there is between gray-level values of different objects in the image. The entropy measures the randomness or homogeneity of the pixel distribution with respect to length or orientation, and it will take a higher value for a more random distribution; it is a measure of the amount of disorder in the image.

The equation for calculating parameters is given by Bharati et al. [18] as:

$$\text{Energy} = \sum \sum P_{\delta}^{2ij}$$

$$\text{Entropy} = - \sum \sum P_{\delta}^{ij} \log_2 P_{\delta}^{ij}$$

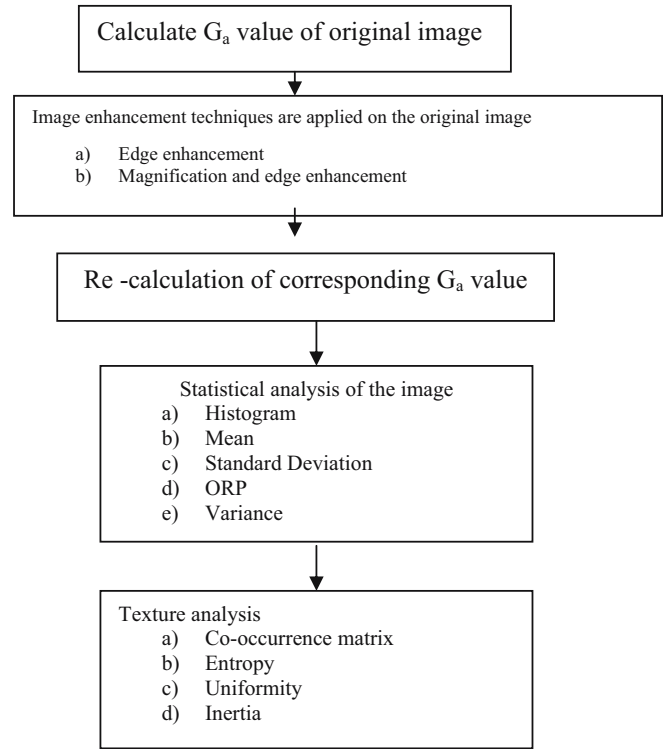

Fig. 5 Flow chart of evaluation steps

4 Chatter identification procedure

4.1 Sample images

The evaluation of surface roughness for the present study is based on the samples obtained from [19]. There are two samples used. The first sample is produced by a turning process with chatter and the other one is a chatter-free sample. The cutting conditions for both of the specimens as well as the displacement amplitudes are shown in Figs. 3 and 4. The corresponding displacement in the Y direction is shown to indicate the presence of chatter, i.e., intensive vibration (Fig. 4).

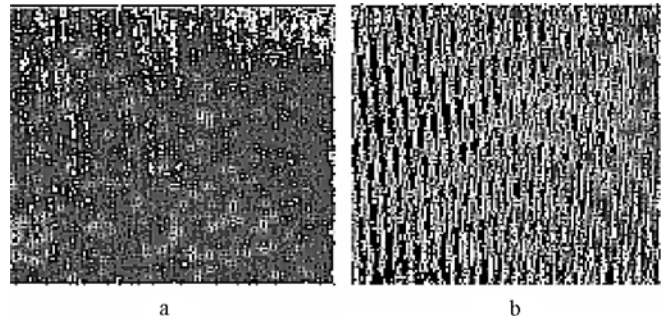

Fig. 6 a Edge enhancement of chatter-free process. b Edge enhancement of chatter-rich process. The corresponding G_a index values are: chatter-rich process $G_a=257.8003$; chatter-free process $G_a=115.9797$

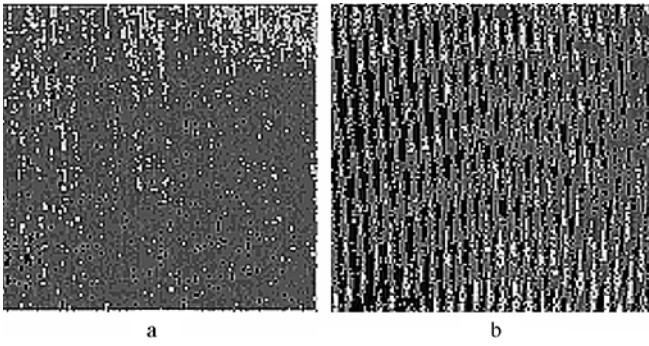
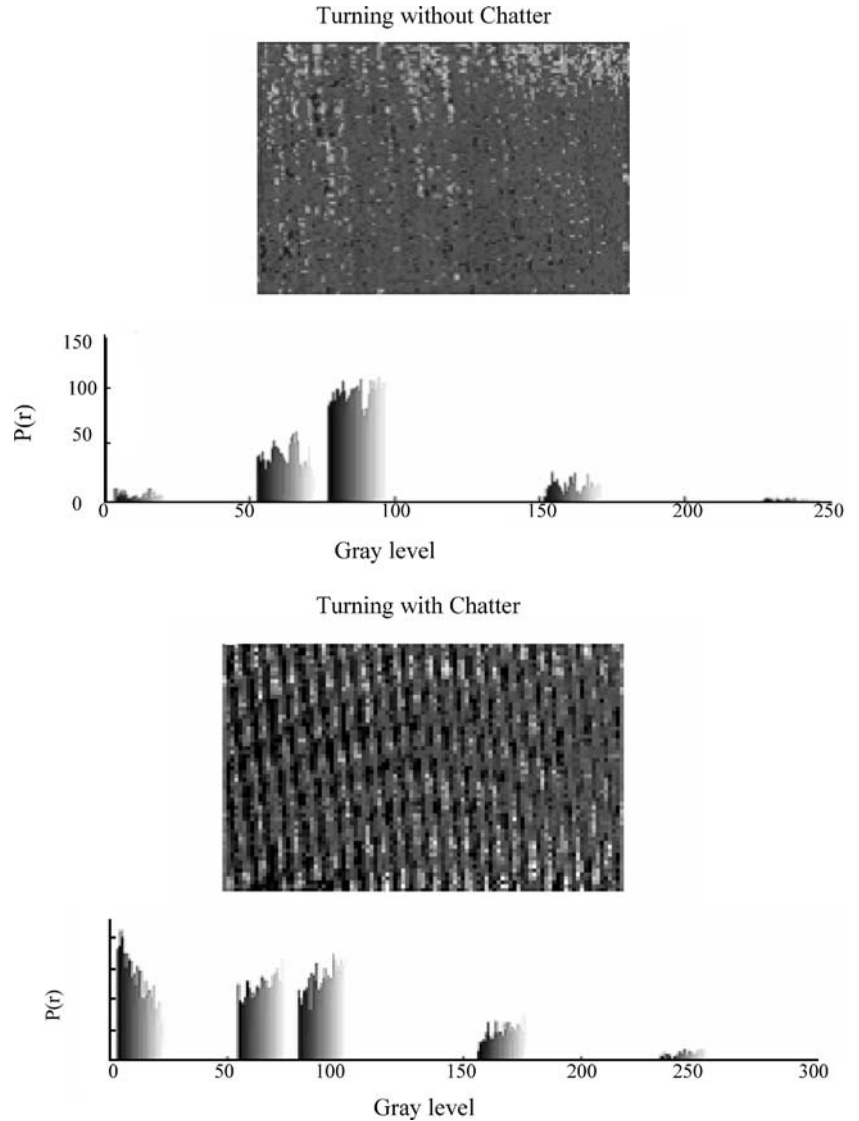

Fig. 7 **a** Magnified and enhanced image of chatter-free process. **b** Magnified and enhanced image of chatter-rich process. The corresponding G_a index values are: chatter-rich process $G_a=104.6320$; chatter-free process $G_a=47.4348$

4.2 Evaluation steps

There are several parameters used to quantify the roughness of the sample images. The flow chart in Fig. 5 shows

Fig. 8 Histogram of the images with/without chatter



the sequence of steps taken to evaluate the surface roughness.

4.3 G_a index of original image

The first parameter computed to evaluate the surface roughness is the arithmetic average of the gray level. A MATLAB program is written to calculate the G_a value and the corresponding value G_a values are:

- Chatter-rich process: $G_a=38.4647$
- Chatter-free process: $G_a=13.9557$

4.4 Edge enhancement and magnification

The second step is to enhance the edges of the images. The composite Laplacian filter or mask is applied to the original image. After that, the G_a index is recalculated. The images

of the samples after the edge enhancement are shown in Fig. 6.

In order to investigate the effect of magnification and edge enhancement on the image, the original images are magnified by the factor of 2 using cubic interpolation convolution. Subsequently, the magnified images are enhanced by a composite Laplacian filter. The resulting images and the corresponding G_a index are shown in Fig. 7.

4.5 Histogram and statistical parameters

The next roughness parameters are based on the statistical features of the images. In order to investigate the difference in the statistical aspect of the images, histograms are first constructed. Figure 8 shows the histograms of the images. From the histograms, it can be seen that the chatter process produces a higher occurrence of gray level in the bright side, whereas in the chatter-free process, the histogram lies in the gray level range of 50–100. This indicates the possibility of identifying chatter from the statistical analysis. Several statistical features are calculated from the image and the summary of the values is shown in Table 1. It is noted that the standard deviation was used instead of the variance which may provide almost identical information.

ORP is the optical roughness parameter introduced by Luk and Huynh [13], which is expressed as the following:

$$\text{ORP} = \frac{\text{std. deviation}}{\text{RMS}}$$

4.6 Texture analysis using GLCM

Texture analysis is carried out to quantify the roughness of the images. GLCM is calculated for the image using MATLAB based on a single displacement vector $\delta=1$ and angle $\theta=0^\circ$. The parameters values derived from the co-occurrence matrices are summarized in Table 2.

5 Analysis and discussion

5.1 G_a index of the images

Table 3 summarizes the G_a index values for the original images, original images with edge enhancement, and also the magnified images with edge enhancement.

From the results obtained, the original image with enhanced edges gives the largest difference in G_a index. In

Table 1 Statistical parameters value

Parameter	Standard deviation	Mean	ORP
Chatter-free	30.7574	88	0.338
Chatter-rich	52.5884	66.67	0.6193

Table 2 Parameter values based on GLCM

Parameter	Energy	Entropy
Chatter-free	0.137	2.574
Chatter-rich	0.0562	3.1863

identifying the presence of chatter, the larger the difference, the easier the identification process will be.

5.2 Histogram and statistical parameters

The histograms of the images indicate the possibility of applying statistical parameters in evaluating roughness and identifying chatter. The image of the sample from a chatter-rich turning process looks brighter because of the presence of chatter marks. On the other hand, the chatter-free sample is darker and the histogram of the pixel values lies in the range of 50–100 gray level.

The mean values give a rough idea of the intensity of the samples. It is obvious that the chatter-free sample is darker than the chatter sample. The standard deviation value of the chatter-free sample is less than that of the chatter sample. This indicates that the chatter-free sample has less variability in the gray level, i.e., it is a smoother surface. Similar to the standard deviation values is the behavior of the values of the variance. The optical roughness parameter is the ratio of the spread to the height of the histogram. It represents the roughness of the surfaces.

5.3 Texture analysis using GLCM

Texture analysis of the image is based on two descriptors, namely, energy and entropy. The values of both descriptors are shown in Table 1. The first descriptor, energy, indicates the uniformity of the texture of the image. In a uniform or homogenous image, there are very few dominant gray-tone transitions; hence, the co-occurrence matrix of this image will have fewer entries of large magnitude. So, the energy will be higher. This agrees with the obtained value of energy. The entropy descriptor provides a measure of randomness of the elements of the matrix. When the elements of the matrix are maximally random, the entropy will be high. The result shows that the chatter-rich sample

Table 3 G_a index values for the three categories of manipulated images

Samples	G_a index		
	Original image	Image+edge enhancement	Magnified image+edge enhancement
Chatter-free sample	13.9557	115.9797	47.4382
Chatter-rich sample	38.4647	257.8003	104.6320
Difference	24.0443	141.8206	57.1938

has a higher value of entropy, which indicates a high level of randomness in the elements.

6 Conclusions

In this paper, we tried to apply image-processing techniques to identify the presence of chatter in machining processes. The case we handled was a turning process with two samples: one with chatter and the other without. We used the G_a index as the basis for analyzing the samples. The G_a index was carried out for three cases: original images, original images with edge enhancement, and magnified images with edge enhancement. The difference in the G_a index values was found to be largest in the case of original images with edge enhancement, which will yield itself to easily identify the presence of chatter. Using the histogram of images led to the possibility of using statistical parameters to identify the presence of chatter. The final step was to use the gray-level co-occurrence matrix (GLCM) to analyze the texture of the samples based on two descriptors: energy and entropy. The results were quite distinct between the chatter-free and the chatter-rich samples.

This work encourages the development of a system based on image processing to identify the presence of chatter in machining processes.

References

- Liang SY, Hecker RL, Landers RG (2004) Machining process monitoring and control: the state-of-the-art. *J Manuf Sci Eng* 126:297–310
- Juneja BL, Sekhon GS (1987) *Fundamentals of metal cutting and machine tools*. Wiley Eastern, New Delhi, India
- Inasaki I, Karpuschewski B, Lee H-S (2001) Grinding chatter—origin and suppression. *Annals CIRP* 50(2):515–534
- Tönshoff HK, Friemuth T, Becker JC (2002) Process monitoring in grinding. *Annals CIRP* 51(2):1–21
- Cho D-W, Lee SJ, Chu CN (1999) The state of machining process monitoring research in Korea. *Int J Mach Tools Manuf* 30(11):1697–1715
- Wang M, Fei RY (2001) On-line chatter detection and control in boring based on an electrorheological fluid. *Mechatronics* 11:779–792
- Gradisek J, Baus A, Govekar E, Klocke F, Grabec I (2003) Automatic chatter detection in grinding. *Int J Mach Tools Manuf* 43:1397–1403
- Cheraghi SH, Lehtihet EA, Egbelu PJ (1994) High-accuracy vision-guided, robotic SMC placement. In: *Proceedings of the 3rd IIE Research Conference, Atlanta, Georgia, May 1994*, vol 2, pp 358–366
- Hoy DEP, Yu F (1991) Surface quality assessment using computer vision methods. *J Mater Process Technol* 28:265–274
- Kumar R, Kulashekar P, Dhanasekar B, Ramamoorthy B (2005) Application of digital image magnification for surface roughness evaluation using machine vision. *Int J Mach Tools Manuf* 45:228–234
- Sodhit MS, Tiliouinet K (1996) Surface roughness monitoring using computer vision. *Int J Mach Tools Manuf* 36(7):817–828
- IEEE (1990) *IEEE Standard Glossary of Image Processing and Pattern Recognition Terminology*. IEEE Standards: 610.4-1990
- Luk F, Huynh V (1987) A vision system for in-process surface quality assessment. In: *Proceedings of the Vision'87 SME Conference, Detroit, Michigan, June 1987*, vol 12, pp 43–58
- Castellano G, Bonilha L, Li ML, Cendes F (2004) Texture analysis of medical images. *Clin Radiol* 59:1061–1069
- Gadelmawla ES, Koura MM, Maksoud TMA, Elewa IW, Soliman HH (2002) Roughness parameters. *J Mater Process Technol* 123:133–145
- Tobias SA (1965) *Machine tool vibration*. Wiley, New York
- Amin AKMN (1965) Investigation of the mechanism of chatter formation during the metal cutting process. *Mech Eng Res Bulletin* 6(1):11–18
- Bharati MH, Liu JJ, Macgregor JF (2004) Image texture analysis: methods and comparisons. *Chemometr Intell Lab Syst* 72:57–71
- Xiao M, Karube S, Soutome T, Sato K (2002) Analysis of chatter suppression in vibration cutting. *Int J Mach Tools Manuf* 42:1677–1685